

PRELIMINARY SPEC

Features

- Low power consumption.
- Popular T-1 3/4 diameter package.
- General purpose leads.
- Reliable and rugged.
- Long life - solid state reliability.
- Available on tape and reel.
- RoHS compliant.

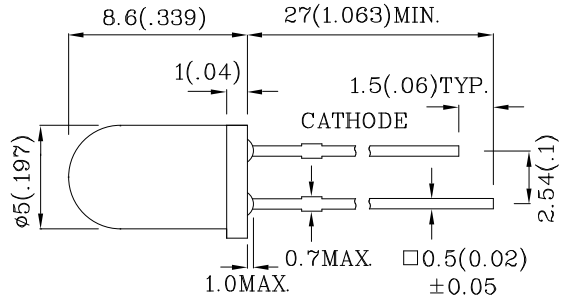
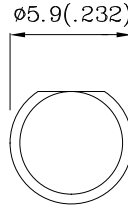

Notes:

1. All dimensions are in millimeters (inches).
2. Tolerance is $\pm 0.25(0.01)$ " unless otherwise noted.
3. Specifications are subject to change without notice.

Absolute Maximum Ratings (TA=25°C)		M2ACY (AlInGaP)	Unit
Reverse Voltage	VR	5	V
Forward Current	IF	30	mA
Forward Current (Peak) 1/10 Duty Cycle 0.1ms Pulse Width	iFS	140	mA
Power Dissipation	PT	75	mW
Operating Temperature	TA	-40 ~ +85	°C
Storage Temperature	Tstg	-40 ~ +85	
Lead Solder Temperature [2mm Below Package Base]	260°C For 3 Seconds		
Lead Solder Temperature [5mm Below Package Base]	260°C For 5 Seconds		

Operating Characteristics (TA=25°C)		M2ACY (AlInGaP)	Unit
Forward Voltage (Typ.) (IF=20mA)	VF	2.0	V
Forward Voltage (Max.) (IF=20mA)	VF	2.5	V
Reverse Current (Max.) (VR=5V)	IR	10	uA
Wavelength of Peak Emission (Typ.) (IF=20mA)	λP	590	nm
Wavelength of Dominant Emission (Typ.) (IF=20mA)	λD	589	nm
Spectral Line Full Width At Half-Maximum (Typ.) (IF=20mA)	$\Delta\lambda$	20	nm
Capacitance (Typ.) (VF=0V, f=1MHz)	C	45	pF

Part Number	Emitting Color	Emitting Material	Lens-color	Luminous Intensity (IF=20mA) mcd		Wavelength nm λP	Viewing Angle 2 θ 1/2
				min.	typ.		
XLM2ACY12W	Yellow	AlInGaP	Water Clear	2200	3790	590	20 °

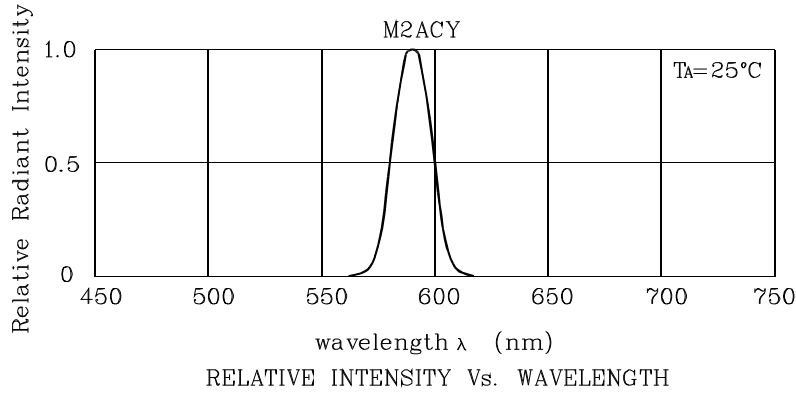

❖ M2ACY

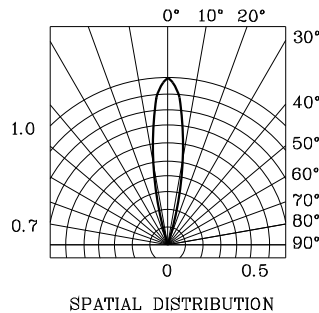
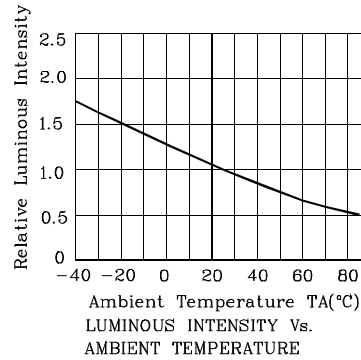
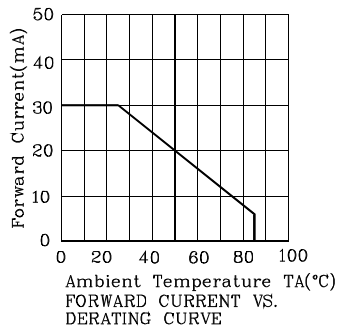
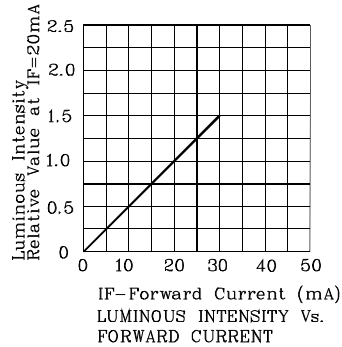
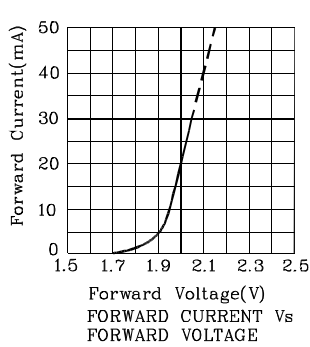

Wave Soldering Profile For Lead-free Through-hole LED.



NOTES:

1. Recommend the wave temperature 245°C~260°C. The maximum soldering temperature should be less than 260°C.
2. Do not apply stress on epoxy resins when temperature is over 85 degree°C.
3. The soldering profile apply to the lead free soldering (Sn/Cu/Ag alloy).
4. No more than once.

Remarks:

If special sorting is required (e.g. binning based on forward voltage, luminous intensity / luminous flux or wavelength), the typical accuracy of the sorting process is as follows:

1. Wavelength: +/-1nm
2. Luminous Intensity / Luminous Flux: +/-15%
3. Forward Voltage: +/-0.1V

Note: Accuracy may depend on the sorting parameters.

PACKING & LABEL SPECIFICATIONS

XLM2ACY12W

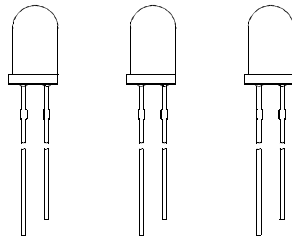

LABEL

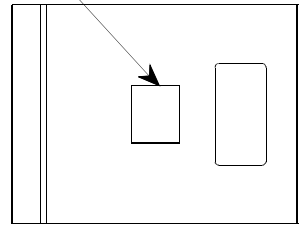

500PCS/BAG

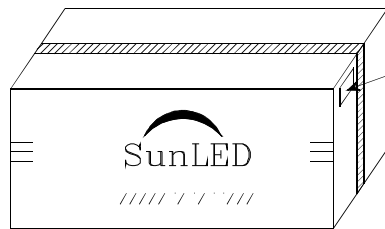

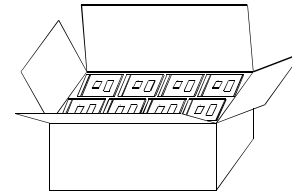

20K/BOX

OUTSIDE LABEL

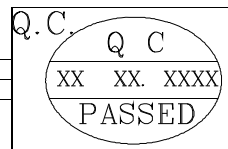

10K/BOX



P/NO : XLxx12x	
QTY : 500 pcs	CODE: XXX
S/N : XX	
LOT NO:	
 XXXXXXXXXXXXXXXXXXXXX	
RoHS Compliant	